

OPTICAL I/O
(FC-UPC)

VIDEO OUTPUT

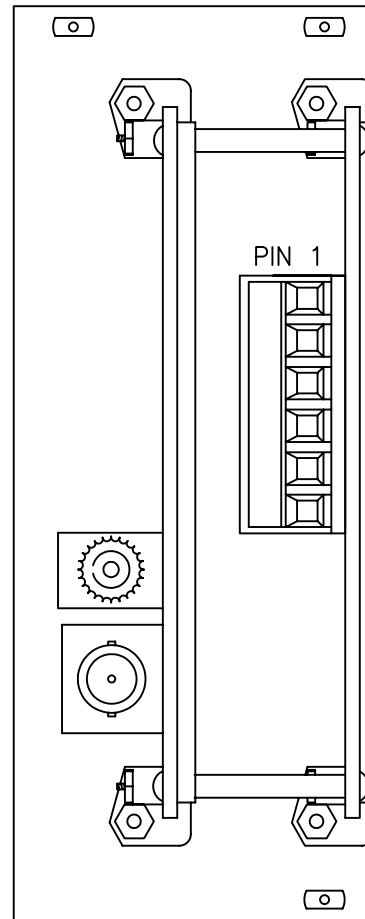

RS485 INPUT -
GROUND
RS485 INPUT +
RS485 OUTPUT -
GROUND
RS485 OUTPUT +

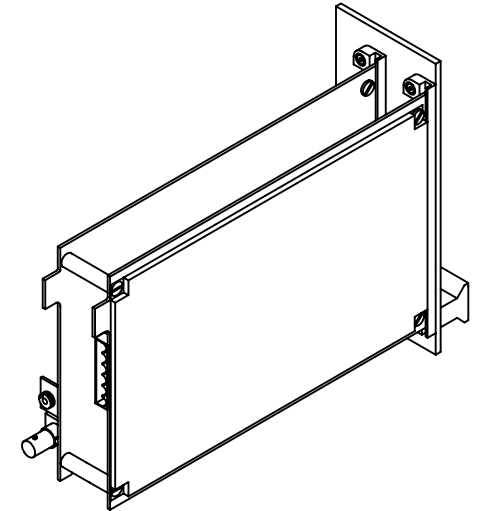

RS485 INPUT IS NOT INTERNALLY TERMINATED. IF A TERMINATION IS REQUIRED, INSTALL A 120Ω 1/4 WATT RESISTOR ACROSS THE DATA(+) AND DATA(-) CONNECTIONS ON THE TERMINAL BLOCK

OLI - OPTICAL LEVEL INDICATOR:
INDICATOR IS GREEN WHEN PROPER LEVEL IS PRESENT. IT IS RED WHEN SIGNAL IS MISSING OR AT INCORRECT LEVEL.

 afi american fibertek 120 BELMONT DRIVE SOMERSET N.J.	DATE: 09 OCT 08		RR-3486-4		
	ACAD FN.: RR-3486-4 CC		CUSTOMER ASSEMBLY DRAWING		
	SCALE: NONE	DWG BY: BLB	DWG. NO.:	SH. 1 OF 1	REV.: