

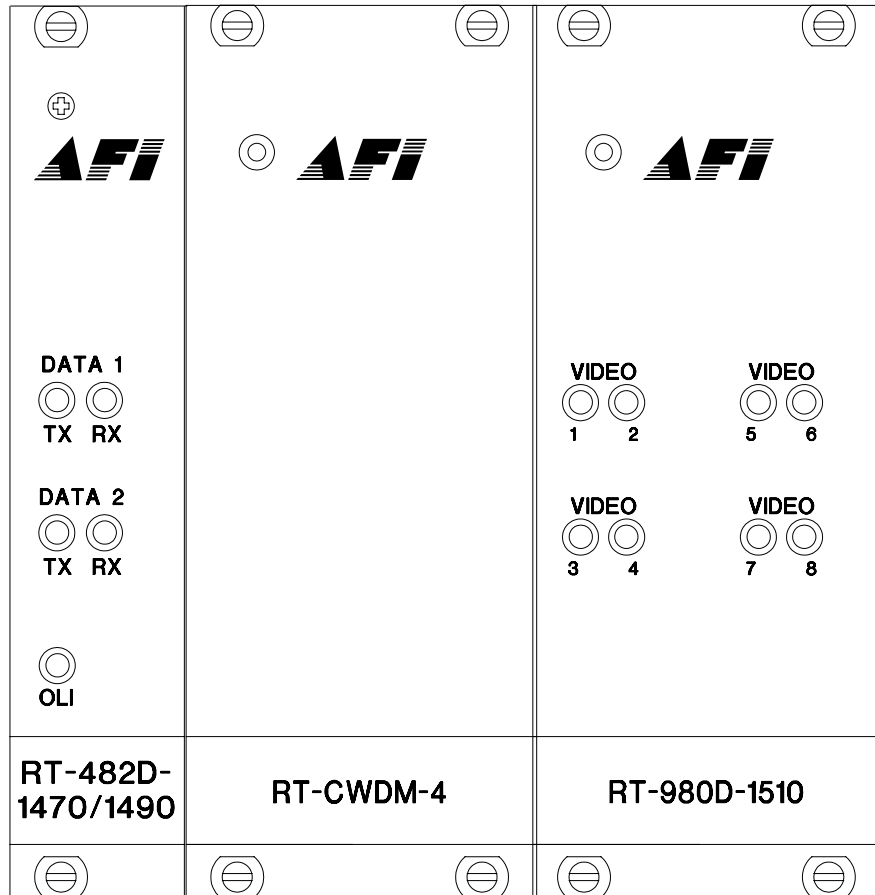

120 Belmont Drive  
Somerset, NJ 08873-1204

**American Fibertek**



Phone: 732.302.0660 Fax: 732.302.0667



## Instruction Manual

### RT-985D-SL

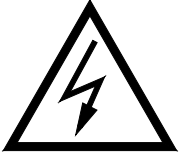
Eight Channel Video Transmitter  
With Two Channels of Multi-Protocol Data  
And Remote Diagnostic Interface

<div style="display: flex; justify-content: space-around; align-items: center;"> <div style="text-align: center;">  </div> <div style="text-align: center;"> <div style="border: 2px solid black; padding: 5px; display: inline-block;"><b>CAUTION</b></div> <p><b>RISK OF ELECTRIC SHOCK, DO NOT OPEN WITH POWER APPLIED</b></p> </div> <div style="text-align: center;">  </div> </div>
<p><b>WARNING: TO PREVENT FIRE OR SHOCK HAZARD, DO NOT EXPOSE THIS UNIT TO RAIN OR MOISTURE</b></p> <p><b>NO USER SERVICEABLE PARTS INSIDE REFER SERVICE TO QUALIFIED SERVICE PERSONNEL</b></p>

## Table of Contents

Functional Description .....	3
Installation .....	4
Power Source .....	4
Power Connection.....	4
Fiber Connections.....	5
Video Input Connections.....	5
Data Input / Output Connections.....	6
Data Configuration Switches.....	7
Data Termination And Bias Switches.....	7
RT-980D-1510 Status LED Indicators.....	9
RT-482D-1470/1490 Status LED Indicators.....	9
Warranty And Service Information .....	8

## INSTALLATION AND OPERATION INSTRUCTIONS

### INTRODUCTION

Thank you for purchasing your American Fibertek Series 985D-SL singlemode eight channel video multiplexer with two channels of multi-protocol data and remote diagnostic interface. Please take a few minutes to read these installation instructions in order to obtain the maximum performance from this product.

### FUNCTIONAL DESCRIPTION

The RT-985D-SL operates as half of a transmitter / receiver pair for the transmission of eight channels of high performance 10 bit digital NTSC, PAL, RS170, or RS343 video signals. The RT-985D-SL also supports combinations of up to two bi-directional RS422, RS232, or RS485 data channels or two return Manchester data channels. The RT-985D-SL is designed to operate with the RR-985D-SL video receiver with bi-directional data over one singlemode fiber optic cable.

The RT-985D-SL multiplexes eight video input signals along with two data signals into a high speed serial data stream. This serial data stream modulates a laser at 1310 nm wavelength. The RT-985D-SL also detects and demultiplexes a return optical serial data stream containing two data signals at 1550 nm wavelength. The 985D-SL Series product is designed to operate on 9 um singlemode fiber over an optical loss budget range of 0 to 15dB. Refer to the data sheets for detailed performance specifications.

The individual components that make up the 985D-SL series units are combined in a rack mount configuration that is inserted into the SR-20D subrack. The RT-985D-SL consists of a RT-980D-1510, a RT-CWDM-4, and a RT-482D-1470/1490. The RT-980D-1510 unit multiplexes eight video inputs onto one distinct singlemode wavelength of 1510 nm. The RT-482D-1470/1490 transmits and receives up to two bi-directional RS422, RS232, or RS485 data channels or two return Manchester data channels using the 1470 nm and 1490 nm wavelengths. The RT-CWDM-4 unit optically multiplexes these distinct wavelengths onto one singlemode fiber.

The RS485 data channel may be configured for 2-wire (half duplex) or 4-wire (full duplex) operation with or without biasing. Switch selectable internal 120 ohm terminations are available for RS422 or RS485 data.

This unit is designed for rack mounting in the American Fibertek SR-20D/2 subrack. Slide in rack mounting, detachable terminal blocks, and LED indicators provide for easy installation and monitoring of video, data, and optical power.

The RT-985D-SL has a built in capability to be remotely monitored through the Afinety Remote Diagnostics System. A SR-20D/2 subrack and a RD-20D diagnostic card are required to facilitate this feature. Please refer to the SR-20D/2 and RD-20D Instruction Manuals for proper operation of this feature.

## INSTALLATION

THIS INSTALLATION SHOULD BE MADE BY A QUALIFIED SERVICE PERSON AND SHOULD CONFORM TO THE NATIONAL ELECTRICAL CODE, ANSI/NFPA 70 AND LOCAL CODES.

The individual rack cards slide into any five slots in the SR-20D subrack. The recommended configuration is shown below. Use a small screwdriver to push and lock the ¼ turn fasteners into place.

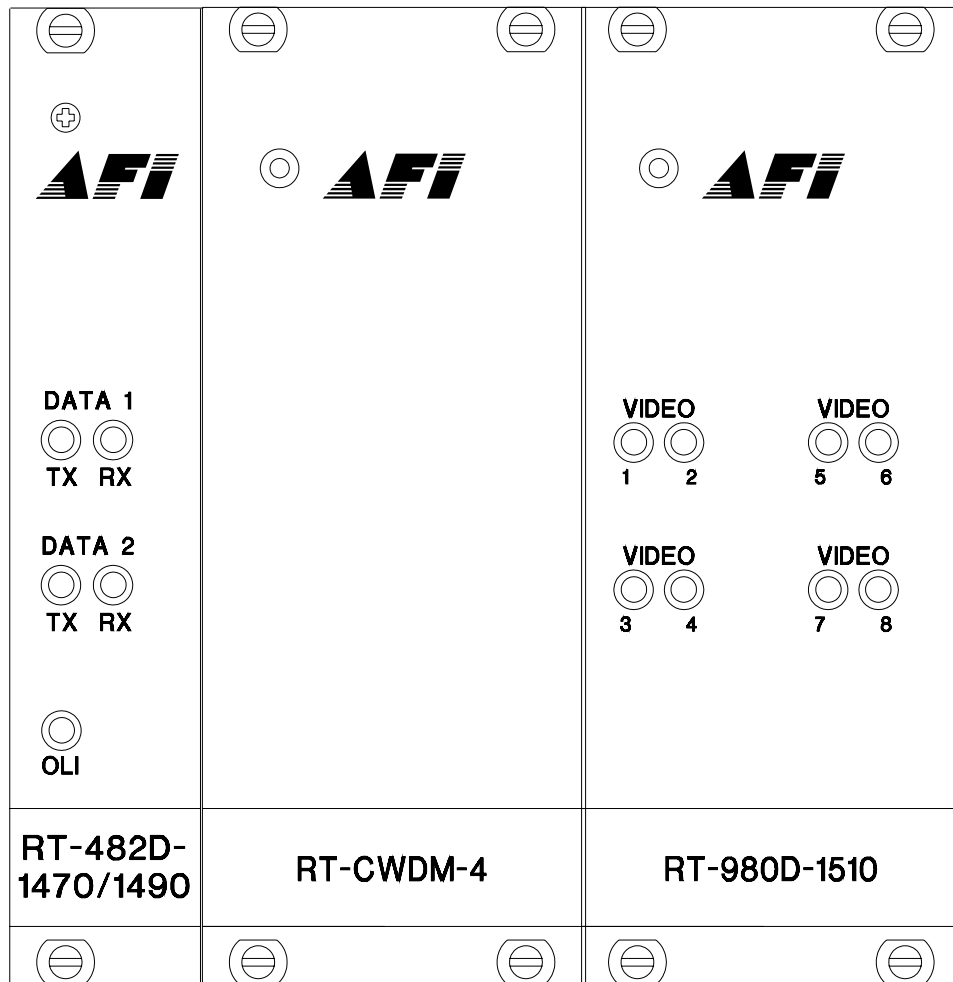

## POWER SOURCE

Power to the unit is supplied by the subrack. Please refer to the SR-20 and PSR-2 instructions for further details.

## POWER CONNECTION

Power is supplied to the individual units via a four finger backplane connector. The individual components can be inserted into the subrack or removed from the subrack with power applied to the backplane.

## FIBER CONNECTIONS

The RT-985D-SL consists of a RT-980D-1510 and a RT-482D-1470/1490 that transmit at different wavelengths. The RT-980D-1510 has one optical port on the back of the unit and the RT-482D-1470/1490 has two optical ports on the back of the unit. A short patch cord (supplied) connects each of these three SC fiber ports to the correspondingly labeled fiber port on the RT-CWDM-4 fiber multiplexer. The fiber optic connection to the site infrastructure is made via a SC connector located on the bottom of the RT-CWDM-4. Be sure to allow sufficient room for the required minimum bend radius of the fiber cable used.

See the drawing below for the RT-985D-SL fiber connections.

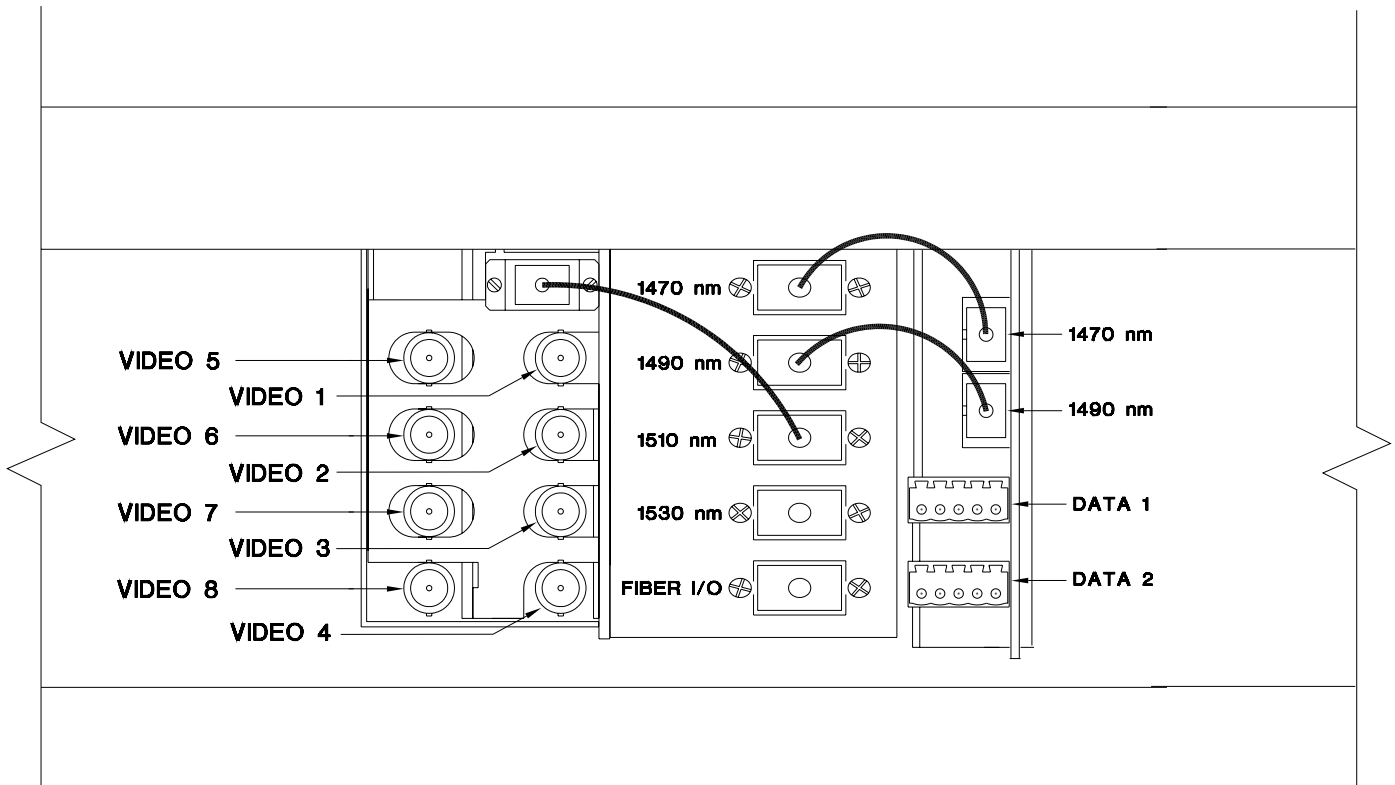

Rear View RT-985D-SL

## VIDEO INPUT CONNECTIONS

Video input connections are located on the rear of the RT-980D-1510 unit. A BNC connector is provided for each channel. The video inputs are connected to an appropriate 75Ω baseband video source such as a camera or a video recorder output. For optimum performance the video cables should be the shortest length of coax practical.

## DATA INPUT / OUTPUT CONNECTIONS

Data input and output connections are made via terminal blocks on the back of the RT-482D-1470/1490 unit. See the drawings below for proper orientation of input and output connections. Please note that the far right pin on each connection drawing corresponds with the far right pin when looking at the terminal block from the back of the unit.

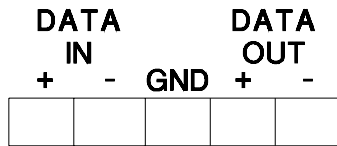

**RS485 4-WIRE  
DATA**

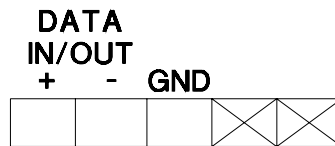

**RS485 2-WIRE  
DATA**

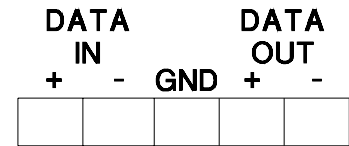

**RS422 DATA**



**RS232 DATA**

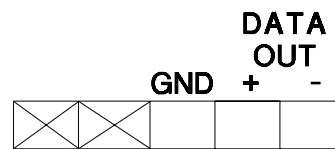

**MANCHESTER  
DATA**

## TYPICAL SYSTEM DATA CONNECTIONS

The RS422 or RS485 four wire interconnection between the RR-945SL and the copper device to which it is attached is based on industry standard EIA terminology for the transmission of electronic data signals. Using this terminology, the driver of an electronic signal is labeled TX or Data Out. Correspondingly, the receiver of an electronic signal is labeled RX or Data In. Following this standard, the Data Out of the copper device is connected to the Data In of the RT-985D-SL. The plus terminal of the copper device is connected to the plus terminal of the RT-985D-SL and the minus is connected to the minus. The reverse flow of data from the RT-985D-SL to the copper device follows the same pattern. Not all manufactures follow standard EIA terminology. Consult the installation instructions for your copper device if you are unsure which two wires are the drive (data out) wires and which two wires are the receive (data in) wires.

Please note that Data In on the RT-985DSL becomes Data Out on the RR-985D-SL after going across the fiber. The reverse flow follows the same orientation.

## DATA CONFIGURATION SWITCHES

**NOTE: This unit is shipped with Data Channel 1 and Data Channel 2 in the RS485 4-wire configuration.**

For other configurations of data channel 1 or data channel 2, please refer to the drawing below for changes to the default switch settings. These configuration switches are located at the bottom of the RT-482D-1470/1490 unit and can be modified without opening the unit.

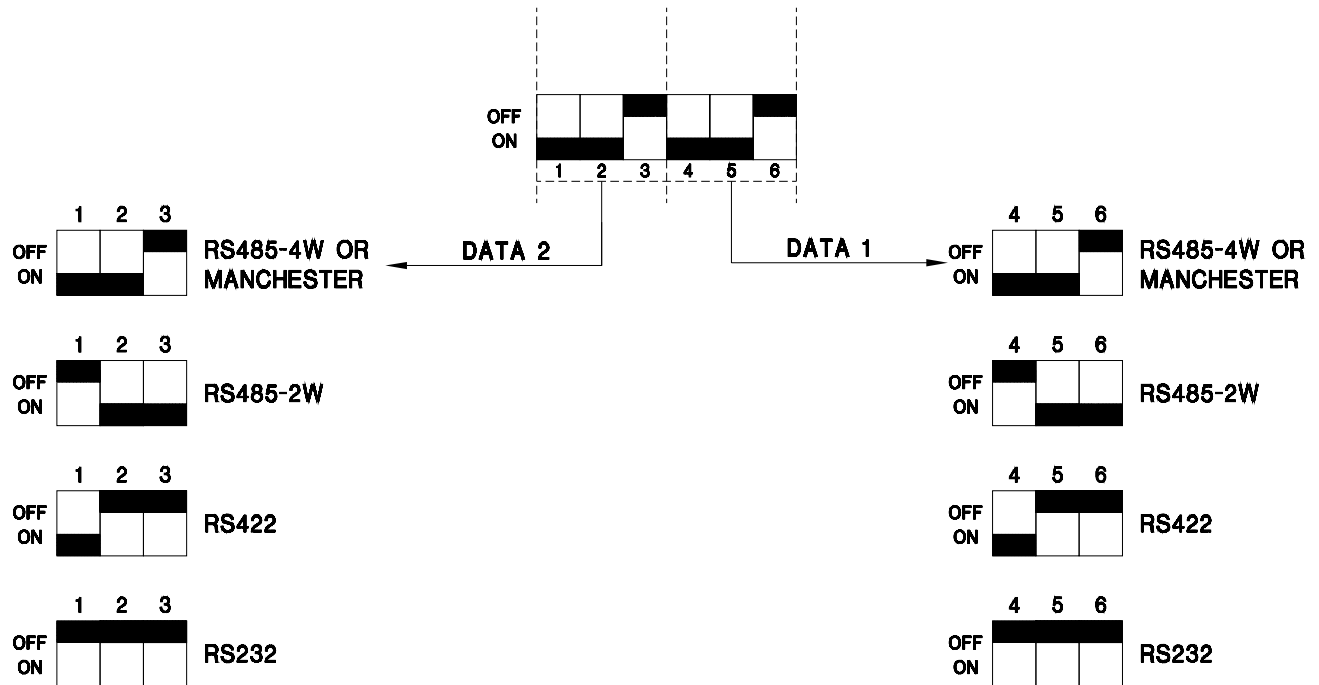

## DATA TERMINATION AND BIAS SWITCHES

**NOTE: This unit is shipped with data terminations off and data bias off for Data Channel 1 and Data Channel 2. For other configurations, please refer to the DATA TERMINATION AND BIAS section on the next page for changes to the default switch settings.**

Switches are available internally on the RT-482D-1470/1490 that allow offset bias and termination features to be activated when using RS485 data. These switches also allow termination features to be activated when using RS422 data. In order to reconfigure the RS485/422 channel, the rack card cover needs to be removed. To access the switches, remove the four screws on the top of the cover. The configuration switch banks are located next to their corresponding data terminal block connector.

The RT-482D-1470/1490 is shipped with these switches in the off position. When transmitting RS232 or Manchester data, the bias and termination switches must remain in the off position. The chart on the next page describes the layout of the S1 switch bank. The switch bank for data channel 2 follows the same pattern.

	ON/CLOSED	OFF/OPEN
S1-1	485/422 INPUT BIAS	NO BIAS
S1-2	485/422 INPUT TERM.	NO TERM.
S1-3	485/422 INPUT BIAS	NO BIAS
S1-4	485/422 OUTPUT BIAS	NO BIAS
S1-5	485/422 OUTPUT TERM.	NO TERM.
S1-6	485/422 OUTPUT BIAS	NO BIAS

Please remember when using offset bias switches that they must be used in pairs. If switch # 1 is on then switch # 3 must also be on. The same situation applies for switch # 4 and switch # 6. Also, if using offset bias, it is important that the corresponding termination resistor switch be in the on position. Using offset bias without a termination on the line will cause communications to fail. An explanation follows on general bias and termination guidelines.

#### RS485 DATA TERMINATION

The RS485 protocol is an expanded version of the original RS422 protocol. RS485 differs from RS422 in the ability of the transmitter devices to go into a high impedance (Hi-Z) state. This allows multiple transmitter devices to reside on the same wire pair. The software must dictate a protocol that allows only one device to transmit at any one time to prevent data crashes. In many cases the system head end controller will continuously poll data from all remote devices. The remote devices all respond back to the head end (one at a time) as they are addressed. The driver chips that are used in RS485 communications are capable of changing into their high impedance state very rapidly. On even short lengths of wire there can exist a residual voltage after a driver circuit turns off. This can interfere with circuits that are used to detect the Hi-Z state. It is very important that the copper communications lines be terminated with resistors across the data wire pair. The best place to locate such resistors is at the furthest electrical devices at the ends of the wire pair. For instance, if several RS485 devices are connected in a daisy chain fashion, the wire connection would loop across all devices in a chain. The furthest two points in the chain would need to be terminated.

#### RS485 OFFSET BIAS

The RS485 specification requires receivers to detect input signals down to 200mVp-p of voltage level. In many cases this can cause systems to be sensitive to noise on the data wires. In an effort to eliminate the effects of low levels of noise, some manufacturers of equipment that communicate using RS485 have introduced a small voltage bias to the data lines. This is usually accomplished using a 470 Ohm resistance to +5V on the positive line and 470 Ohm resistance to ground on the negative line. When used in conjunction with the appropriate termination resistors referred to in the previous section, this introduces about a 300 mV offset, improving noise immunity.



## RT-980D-1510 STATUS INDICATORS

The RT-980D-1510 transmitter provides the following front panel LED status indicators to aid in installation and troubleshooting:

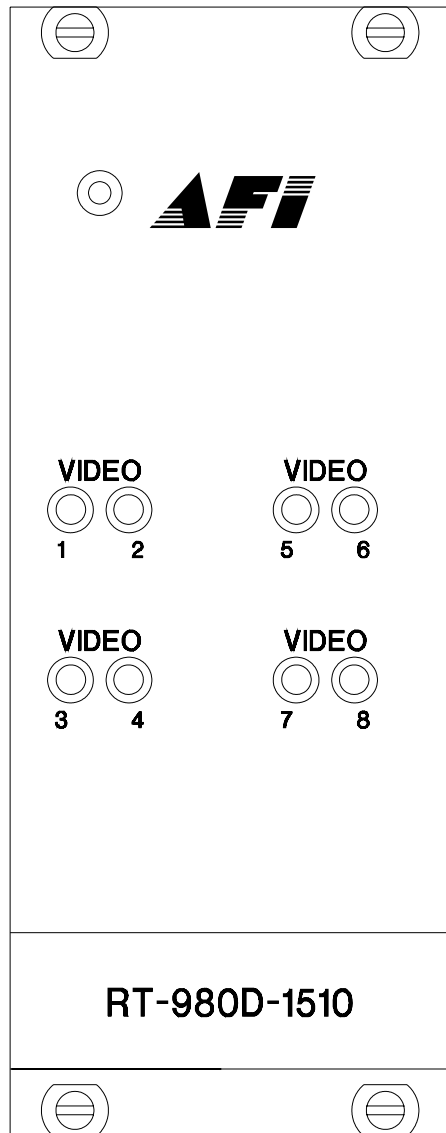

### VIDEO 1 THROUGH VIDEO 8

A bi-color LED indicator is provided for each of the eight video channel inputs. DC power and video status associated with each of these LEDs are summarized below.

Video Presence LED	DC Power Status	Video Status
Green	On	Proper Input Video Present
Red	On	Input Video Not Detected
Off	Off	Check Rack Card Seating

## RT-482D-1470/1490 STATUS INDICATORS

The RT-482D-1470/1490 transmitter provides the following front panel LED status indicators to aid in installation and troubleshooting:

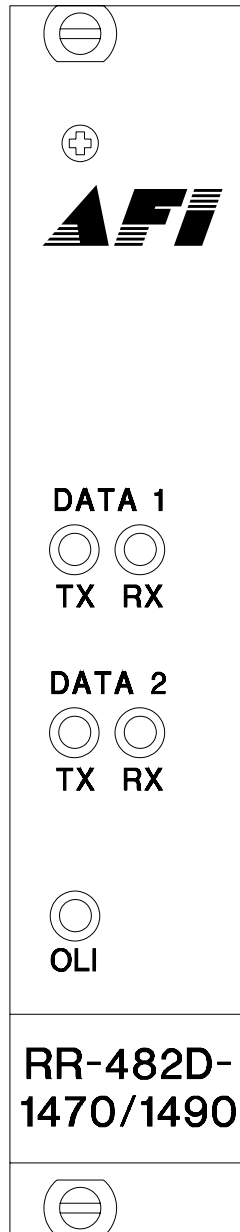

### DATA TX / RX INDICATORS

DATA TX and DATA RX indicators are provided to monitor each of the two available data channels. These indicators are described on the following page.

### DATA TX

A green LED indicator is provided to monitor the data coming in from the electrical interface, through the RT-482D-1470/1490, and out onto the fiber. The intensity of this indicator will vary with input data patterns, however in typical applications it will cycle on and off as data is transmitted. Data transmitted status associated with this LED is summarized below.

DATA TX LED	Data Status
Green	Data Flow Present
Off	Data Flow Not Detected

### DATA RX

A green LED indicator is provided to monitor the data coming in from the fiber, through the RT-482D-1470/1490, and out onto the electrical interface. The intensity of this indicator will vary with input data patterns, however in typical applications it will cycle on and off as data is received. Data received status associated with this LED is summarized below.

DATA RX LED	Data Status
Green	Data Flow Present
Off	Data Flow Not Detected

### OLI

A bi-color LED indicator monitors the power of the optical input signal that is being received at the RT-482D-1470/1490 from the corresponding RR-482D-1470/1490. DC power and optical input status associated with this LED are summarized below.

Optical Level Indicator	DC Power Status	Optical Status
Green	On	Proper Optical Input Power Present
Red	On	Optical Input Not Detected
Off	Off	Check Rack Card Seating

**This unit complies with 21 CFR  
1040.10 and 1040.11**

#### LIFETIME WARRANTY INFORMATION

American Fibertek, Inc warrants that at the time of delivery the products delivered will be free of defects in materials and workmanship. Defective products will be repaired or replaced at the exclusive option of American Fibertek. A Return Material Authorization (RMA) number is required to send the products back in case of return. All returns must be shipped prepaid. This warranty is void if the products have been tampered with. This warranty shall be construed in accordance with New Jersey law and the courts of New Jersey shall have exclusive jurisdiction over this contract. **EXCEPT FOR THE FOREGOING WARRANTY, THERE IS NO WARRANTY OF MERCHANTABILITY OR FITNESS FOR A PARTICULAR PURPOSE OR OTHERWISE, EXPRESSED OR IMPLIED, WHICH EXTENDS BEYOND THE WARRANTY SET FORTH IN THIS AGREEMENT.** In any event, American Fibertek will not be responsible or liable for contingent, consequential, or incidental damages. No agreement or understanding, expressed or implied, except as set forth in this warranty, will be binding upon American Fibertek unless in writing, signed by a duly authorized officer of American Fibertek.

#### SERVICE INFORMATION

There are no user serviceable parts inside the unit.

In the event that service is required to this unit, please direct all inquiries to:

American Fibertek, Inc.  
120 Belmont Drive  
Somerset, NJ 08873

Phone: (877) 234-7200  
Phone: (732) 302-0660  
FAX (732) 302-0667

E-mail: [techinfo@americanfibertek.com](mailto:techinfo@americanfibertek.com)